

LIZFLEX

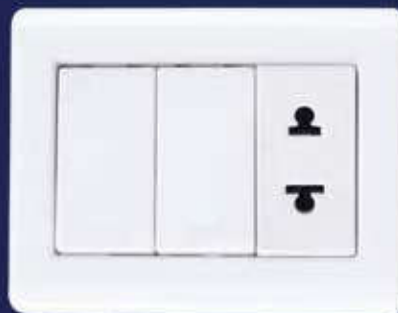

Modular line overlap. Dispenses the use of screws.

Linea modular de sobreponer. Dispensa el uso de tornillos.

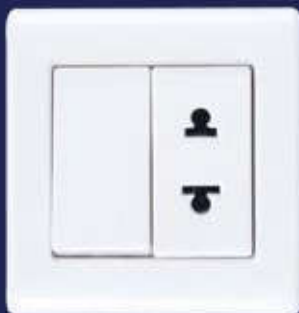
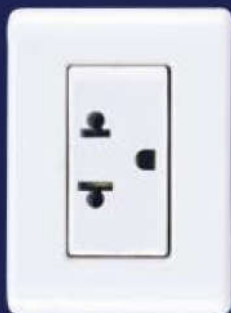

CHARACTERISTICS | CARACTERÍSTICAS

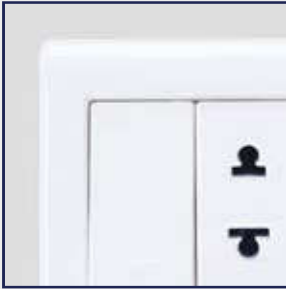

Produced in thermoplastic. There are 03 types of boxes overlap, in white and beige colors, glossy finishing. With 01, 02 and 03 modules.
Producido en termoplástico. Hay 03 tipos de cajas de superposición, en colores blanco y beige, acabado brillante. Con 01, 02 y 03 módulos.



Conductors fixed to the terminals and locked by screw to a perfect contact.
Conductores fijados a los bornes y bloqueados por tornillos para un contacto perfecto.



Cover for simple pressure fitting, glossy finishing.
Tapa por simple encaje a presión, acabado brillo.



Lizflex Multiuso: Cajas que sirven tanto para uso con canaletas como electroductos.
Lizflex Multipurpose: Boxes that serve for use with tracks and conduit pipes.



Modules for different functions.
Módulos para distintas funciones.



Detachable windows to inlay tracks 20x10, 40x20 and 50x20 mm.
Ventanas destacables para empotrar canaletas 20x10, 40x20 y 50x20 mm.

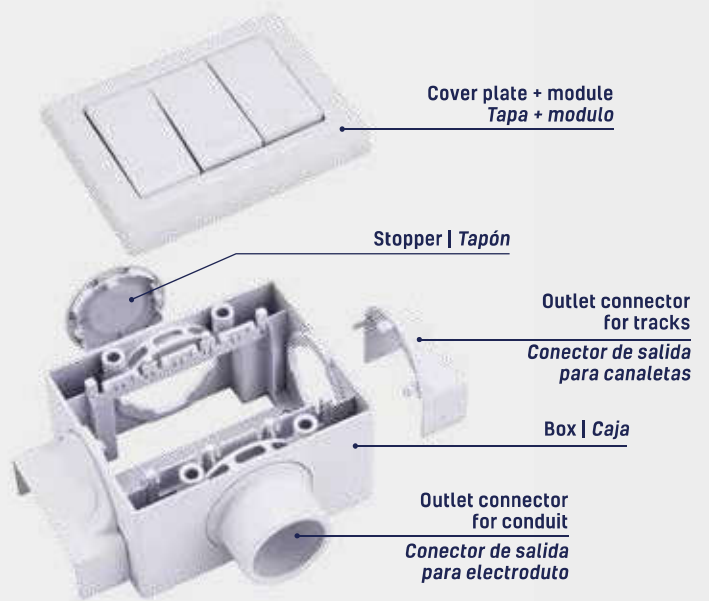

Modular System in two parts: box + plate. Does not include screw for fixing to walls.

Systema Modular en dos piezas: caja + tapa. No acompaña tornillo para fijación en paredes.



BOXES AND SETS | CAJAS Y CONJUNTOS



57303/001
57303/011



57303/002
57303/012



57303/003
57303/013

REF.	PKG	EMB	789.1435.	DESCRIPTION DESCRIPCIÓN	COLOR
boxes without accessories cajas sin accesorios					
57303/001	20	05219	0	box caja 1 gang wall puesto	White
57303/011					White
57303/002	20	05220	6	box caja 2 gang walls puestos	White
57303/012					White
57303/003	20	05221	3	box caja 3 gang walls puestos	White
57303/013					White



57304/001
57304/005

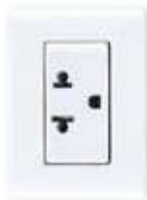

57304/004

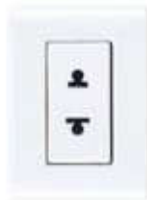

57304/008



57304/007



57304/010
57304/017

boxes 1 place with accessories | cajas 1 puesto con accesorios

57304/001	10	01729	8	1 simple switch 1 interruptor simples 10A - 250V~	White
57304/004	10	01730	4	1 2P+T universal outlet 1 toma Universal 2P+T 10A - 250V~	White
57304/005	10	05300	5	1 interruptor parallel 1 switch interruptor escalera 10A - 250V~	White
57304/007	10	01732	8	1 ringer pulsator 1 interruptor campanilla 10A - 250V~	White
57304/008	10	0534	6	1 2P universal outlet 1 toma universal 2P 10A - 250V~	White
57304/010	10	05347	0	1 RJ11 simple phone outlet 1 toma teléfono simple RJ11	White
57304/017	10	05695	2	1 RJ45 outlet [cat.6] 1 toma RJ45 [cat.6]	White

*CHECK THE TECHNICAL INFORMATION ON PAGES 112 AND 113.
*VER LAS CARACTERÍSTICAS TÉCNICAS EN LAS PÁGINAS 112 Y 113.



57304/011



57304/014



57304/015

boxes 2 places with accessories | cajas 2 puestos con accesorios

57304/011	10	05278	7	2 simple switches 2 interruptores simples 10A/15A - 250V~	White
57304/014	10	05280	0	1 inter. simples + 1 toma 2P univ. 1 simple switch + 1 2P univ. outlet 10A/15A - 250V~	White
57304/015	10	05349	4	2 tomacorrientes 2P universal 2 2P universal outlets 10A/15A - 250V~	White

*CHECK THE TECHNICAL INFORMATION ON PAGES 112 AND 113.
*VER LAS CARACTERÍSTICAS TÉCNICAS EN LAS PÁGINAS 112 Y 113.